



APPAREL CATALOGUE
2019 | 2020

VER. 2



LATEST COLLECTION



ULTIFRESH APPARELS



ABOUT US

Ultifresh is an Anti-bacterial & Anti-odor brand that produces sustainable & eco-friendly apparels. Our distribution range includes non-decorated blank apparels such as t-shirts polo t-shirts, jackets which are subsequently printed or embroidered with designs and logos.

FUNCTION

Remove Bacteria & Odor

- All Ultifresh products have Anti-Bacterial & Anti-Odor technology

Very Durable

- Lesser bacteria means lesser fabric fibers destroyed

Saves Water

- Only need to wash after wearing a few times

ULTIFRESH WHY CHOOSE US

BENEFITS

USERS

- Lesser washing required
- Prevents bacteria from spreading to other clothes when washing

Environment

- Eco-Friendly
- Global effort to save water
- Reduce textile wastage

Company

- Save costs by providing lesser uniforms

READY MADE

- Attractive price
- Fast delivery lead time
- Internationally certified
- Minimum order from 1 Piece onwards
- Standard Asian size chart
- Up to 25 outstanding and vibrant colors for our basic collections

SINGAPORE CUSTOM-MADE

1. Full Customization

- 5000 fabric selection to choose from
- Customize own buttons and zips with logo imprinted
- More than 10 types of fabric treatments
- More than 19 different types types of logo imprint method
- Private labels and brands labels customization available

2. Specialization

- T-Shirt, polo t-shirt, corporate button shirt, corporate jackets, school jackets, biker jackets, windbreakers, hoodies, overalls, aprons, pants etc

ABOUT ULTIFRESH

Ultifresh is a patented fabric technology that kills 99.94% bacteria permanently. The anti-bacterial & anti-odor features can be integrated into any fabric without affecting the outlook and the hand feel of the apparel.

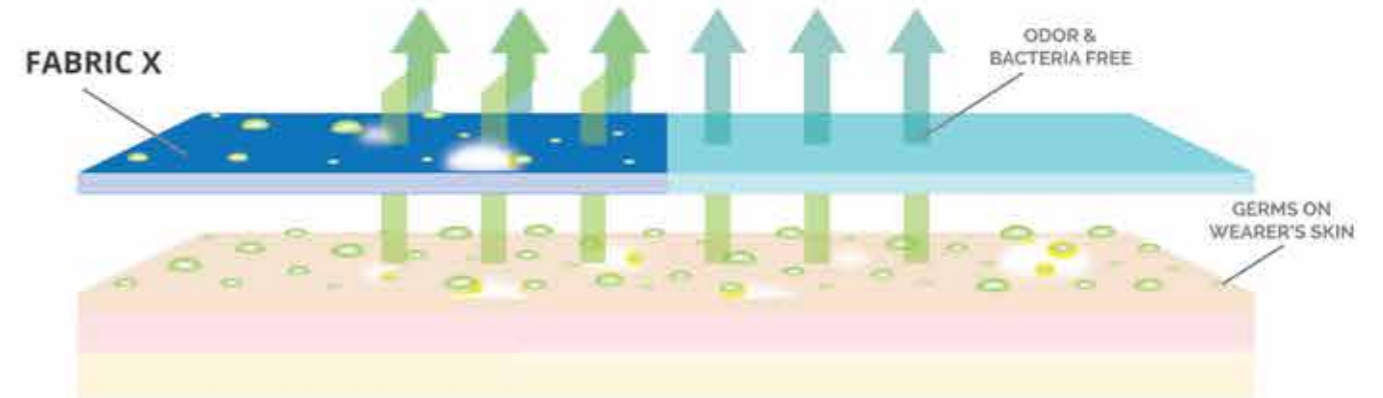

BENEFITS OF ULTIFRESH

Ultifresh products are designed with copper's anti-microbial properties, allowing it to self sterilize. It can also prevent bacteria growth, making it a safer apparel for everyone.



ANTI-ODOR

Ultifresh technology eliminates odor causing germs on the fabric itself, leaving the wearer fresh all day long.



INCREASED DURABILITY

Ultifresh prevents microbes from living on the apparel. Thus, it increases the longevity of the apparel, resulting into lesser textile wastage each year.



ANTI-BACTERIAL

We come into contact with thousands of unseen bacteria everyday. Ultifresh fabric solution kills bacteria minutes upon contact.



SAVES WATER

Ultifresh apparels require lesser wash cycle and water usage up to 75% ! This unique features allows the wearer to save water without compromising safety.



COST SAVING

Ultifresh lowers the turnover of uniforms and apparels due to its durability, which allows wearer to wear longer without washing



ECO - FRIENDLY

Ultifresh supports the global Go-Green effort in conserving the Earth's natural resources such as water and reducing textile wastage.

CONTENT

- Latest Collection 1 - 2
- Why Choose Us 3
- About Ultifresh 4

1. Ultifresh Performance Series

- Crew Neck 6 - 11
- Polo T-Shirt 12 - 16

2. Ultifresh Design Series

- Raglan Series 17 - 20
- Contrast Series 21 - 32
- Burst Series 33 - 36
- Oriental Series 37 - 40
- Heather Series 41 - 46
- Hybrid Series 47 - 52
- Pique Series 53 - 58

3. Ultifresh Outerwear Series

- Bomber Jacket 59 - 60
- Full Moon Zip Up Jacket 61 - 62
- Varsity Jacket 63 - 64

4. Essential Series

- Collar Fleece Zip Up Jacket 67 - 70
- Hoodie Without Zip 71 - 72
- Hoodie With Zip 73 - 74
- Jacket In A Bag 75 - 76
- Soft Cardigan 77 - 78
- V Neck Sweater 79 - 80
- Cotton Polo T-Shirt 81 - 82
- Cotton Short Sleeve T-Shirt 83 - 84
- Cotton Short Sleeve T-Shirt (Kids) 85
- Polyester Apron 86
- Crew Neck Long Sleeve 87 - 88
- Corporate Wear 89
- Oxford Corporate Shirt 90
- Corporate Unisex Shirt (Long Sleeve) 91 - 92
- Corporate Unisex Shirt (Short Sleeve) 93
- Corporate Female Shirt (Short Sleeve) 94
- Corporate Female Shirt (Long Sleeve) 94
- 2 Button Fitted Blazer 95 - 98

5. Customization

- Ultifresh Customization 99 - 100
- Polo T-Shirt Styles 101 - 102
- Jacket Styles 103 - 104
- Buttons Styles 105 - 106
- Zipper Head Styles 106



- * 100% Performance Dri-Fit Polyester
- * Microfiber Polyester Eyelet



ULTIFRESH PERFORMANCE

CREW NECK T-SHIRT (KIDS CUT)

SIZE	SHOULDER	CHEST	SLEEVE	LENGTH
24	11.5"	25"	4.5"	15.5"
26	12"	27"	5"	17"
28	12.5"	29"	5.5"	18.5"
30	13"	31"	6"	20"
32	13.5"	33"	6.5"	21.5"

Note: Size may varies +/-5% from the above mentioned chart.

- * 170GSM | 5.01oz (UDF2201)
- * 160GSM | 4.72oz (THE REST)

UDF22

COLORS SELECTION



ULTIFRESH 2019
MODEL: MICHELLE
— UDF1213 —

ULTIFRESH 2019
MODEL: FRANCO
— UDF0123 —

ULTIFRESH PERFORMANCE

CREW NECK T-SHIRT (UNISEX)

- * 100% Performance Dri-Fit Polyester
- * Microfiber Polyester Eyelet
- * Anti Bacterial & Anti Odor Finishing
- * Self Fabric Collar
- * Eco-Friendly & Water Saving

SIZE	SHOULDER	CHEST	SLEEVE	LENGTH
2XS	15"	34"	7"	25"
XS	16"	36"	7.5"	26"
S	17"	38"	8"	27"
M	18"	40"	8.5"	28"
L	19"	42"	9"	29"
XL	20"	44"	9.5"	30"
2XL	21"	46"	10"	31"
3XL	22"	48"	10.5"	32"

Note: Size may varies +/-5% from the above mentioned chart.

* 170GSM | 5.01oz (UDF0101)

* 160GSM | 4.72oz (THE REST)

UDF01 COLORS SELECTION



SGS
TEST REPORT

Intertek
Total Quality. Assured.

ULTIFRESH PERFORMANCE

CREW NECK T-SHIRT (FEMALE CUT)



ULTIFRESH 2019
MODEL: MICHELLE
UDF1216



FRONT VIEW

BACK VIEW

- * 100% Performance Dri-Fit Polyester
- * Microfiber Polyester Eyelet
- * **FEMALE** Cutting
- * Eco-Friendly & Water Saving

SIZE	SHOULDER	CHEST	SLEEVE	LENGTH
S	13"	32"	6"	22.5"
M	14"	34"	6.5"	23.5"
L	15"	36"	6.5"	24.5"
XL	16"	38"	7"	25.5"
2XL	17"	40"	7"	26.5"

Note: Size may varies +/-5% from the above mentioned chart.

* 170GSM | 5.01oz (UDF1201)

* 160GSM | 4.72oz (THE REST)



UDF12 COLORS SELECTION



UDF1201
PEARL WHITE



UDF1202
ONYX BLACK



UDF1203
NAVY BLUE



UDF1204
CRIMSON RED



UDF1212
ROYAL BLUE



UDF1213
ORANGE



UDF1216
BANANA



UDF1223
ROYAL PURPLE



ULTIFRESH PERFORMANCE

CREW NECK LONG SLEEVE T-SHIRT (UNISEX)

SIZE	SHOULDER	CHEST	SLEEVE	LENGTH
XS	16"	36"	20"	26"
S	17"	38"	21"	27"
M	18"	40"	22"	28"
L	19"	42"	23"	29"
XL	20"	44"	23.5"	30"
2XL	21"	46"	23.5"	31"
3XL	22"	48"	23.5"	32"

Note: Size may varies +/-5% from the above mentioned chart.
* 160GSM | 4.72oz

- * 100% Performance Dri-Fit Polyester
- * Microfiber Polyester Eyelet
- * Eco-Friendly & Water Saving



ULTIFRESH PERFORMANCE

POLO LONG SLEEVE T-SHIRT (UNISEX)

SIZE	SHOULDER	CHEST	SLEEVE	LENGTH
XS	16"	36"	20"	26"
S	17"	38"	21"	27"
M	18"	40"	22"	28"
L	19"	42"	23"	29"
XL	20"	44"	23.5"	30"
2XL	21"	46"	23.5"	31"
3XL	22"	48"	23.5"	32"

Note: Size may varies +/-5% from the above mentioned chart.
* 160GSM | 4.72oz

- * 100% Performance Dri-Fit Polyester
- * Microfiber Polyester Eyelet
- * Eco-Friendly & Water Saving

UDF26 COLORS SELECTION



UDF2601
WHITE



UDF2602
BLACK



UDF2603
NAVY



UDF2607
IRON GREY



UDF2613
ORANGE



UDF2621
BASIL GREEN

UDF27 COLORS SELECTION



UDF2701
WHITE



UDF2702
BLACK



UDF2703
NAVY BLUE



UDF2705
MAROON



UDF2707
IRON GREY



UDF2710
LIGHT BLUE



UDF2712
ROYAL BLUE



UDF2713
ORANGE



UDF2721
BASIL GREEN

ULTIFRESH 2019
MODEL: ETIENNE
— UDF0508 —



ULTIFRESH PERFORMANCE

POLO T-SHIRT (UNISEX)

- * 100% Performance Dri-Fit Polyester
- * Microfiber Polyester Eyelet
- * Anti Bacterial & Anti Odor Finishing
- * Matching Collar Rib
- * Eco-Friendly & Water Saving

SIZE	SHOULDER	CHEST	SLEEVE	LENGTH
2XS	15"	34"	7"	25"
XS	16"	36"	7.5"	26"
S	17"	38"	8"	27"
M	18"	40"	8.5"	28"
L	19"	42"	9"	29"
XL	20"	44"	9.5"	30"
2XL	21"	46"	10"	31"
3XL	22"	48"	10.5"	32"

Note: Size may varies +/-5% from the above mentioned chart.

* 170GSM | 5.01oz (UDF0101)

* 160GSM | 4.72oz (THE REST)

UDF05

COLORS SELECTION



ULTIFRESH PERFORMANCE

POLO T-SHIRT (FEMALE CUT)

ULTIFRESH 2019
MODEL: SANA K
UD1804



- * 100% Performance Dri-Fit Polyester
- * Microfiber Polyester Eyelet
- * **FEMALE** Cutting
- * Eco-Friendly & Water Saving

SIZE	SHOULDER	CHEST	SLEEVE	LENGTH
S	13"	32"	6"	22.5"
M	14"	34"	6.5"	23.5"
L	15"	36"	6.5"	24.5"
XL	16"	38"	7"	25.5"
2XL	17"	40"	7"	26.5"

Note: Size may varies +/-5% from the above mentioned chart.

* 170GSM | 5.01oz (UDF1801)

* 160GSM | 4.72oz (THE REST)



UDF18 COLORS SELECTION



UDF1801
PEARL WHITE



UDF1802
ONYX BLACK



UDF1803
NAVY BLUE



UD1804
CRIMSON RED



UDF1812
ROYAL BLUE



UDF1813
ORANGE



UDF1816
BANANA



UD1823
ROYAL PURPLE

ULTIFRESH 2019
MODEL: FRANCO
— UDF0312 —

ULTIFRESH 2019
MODEL: MICHELLE
— UDF0304 —



Contrast Raglan
Sleeve & Raglan Cut

Anti-Bacterial
& Anti-Odor
Finishing



BACK
VIEW

FRONT
VIEW

- * 100% Dri-Fit Polyester
- * Interlock Weave
- * Moisture Wicking & Sweat Absorbent
- * Eco-Friendly & Water Saving

ULTIFRESH RAGLAN

SHORT SLEEVE T-SHIRT

SIZE	CHEST	SLEEVE	LENGTH
2XS	34"	14.5"	25"
XS	36"	15.5"	26"
S	38"	16.5"	27"
M	40"	17.5"	28"
L	42"	18.5"	29"
XL	44"	19.5"	30"
2XL	46"	20.5"	31"
3XL	48"	21.5"	32"

Note: Size may varies +/-5% from the above mentioned chart.

* 160GSM | 4.72oz

UDF03 COLORS SELECTION



UDF0312
WHITE + BLUE



UDF0301
WHITE + RED



UDF0336
WHITE + ORANGE



UDF0302
BLACK + WHITE



UDF0304
RED + WHITE



UD0316
YELLOW + WHITE



ULTIFRESH 2019
MODEL: ETIENNE
— UDF1616 —



ULTIFRESH 2019
MODEL: SANA K
— UDF1612 —

Contrast Raglan
Sleeve & Raglan Cut

Anti-Bacterial
& Anti-Odor
Finishing



BACK
VIEW

FRONT
VIEW

- * 100% Dri-Fit Polyester
- * Interlock Weave
- * Moisture Wicking & Sweat Absorbent
- * Eco-Friendly & Water Saving

ULTIFRESH RAGLAN LONG SLEEVE T-SHIRT

SIZE	CHEST	SLEEVE	LENGTH
XS	36"	28"	26
S	38"	29.5"	27"
M	40"	31"	28"
L	42"	32.5"	29"
XL	44"	33.5"	30"
2XL	46"	34.5"	31"
3XL	48"	35"	32"

Note: Size may varies +/-5% from the above mentioned chart.

* 160GSM | 4.72oz

UDF16 COLORS SELECTION



UDF1612
WHITE + BLUE



UDF1601
WHITE + RED



UDF1636
WHITE + ORANGE



UDF1602
BLACK + WHITE



UDF1604
RED + WHITE



UD1616
YELLOW + WHITE

SGS
TEST REPORT

intertek
Total Quality Assured.



ULTIFRESH 2019
MODEL: FRANCO
UDF0710



ULTIFRESH 2019
MODEL: MICHELLE
UDF0723



Anti-Bacterial
& Anti-Odor
Finishing

Contrast
Collar Rib



BACK
VIEW

FRONT
VIEW

- * 100% Dri-Fit Polyester
- * Interlock Weave
- * Moisture Wicking & Sweat Absorbent
- * Eco-Friendly & Water Saving

ULTIFRESH CONTRAST

SIDE PANEL CREW NECK T-SHIRT

SIZE	SHOULDER	CHEST	SLEEVE	LENGTH
2XS	15"	34"	7"	25"
XS	16"	36"	7.5"	26"
S	17"	38"	8"	27"
M	18"	40"	8.5"	28"
L	19"	42"	9"	29"
XL	20"	44"	9.5"	30"
2XL	21"	46"	10"	31"
3XL	22"	48"	10.5"	32"

Note: Size may varies +/-5% from the above mentioned chart.

* 160GSM | 4.72oz

UDF07 COLORS SELECTION



UDF0701
WHITE + ORANGE



UDF0702
BLACK + WHITE



UDF0703
NAVY + WHITE



UDF0710
LIGHT BLUE + WHITE



UDF0723
PURPLE + WHITE



UDF0733
BLUE + ORANGE

SGS
TEST REPORT

intertek
Total Quality Assured.



ULTIFRESH 2019
MODEL: MICHELLE
— UDP0816 —

ULTIFRESH 2019
MODEL: FRANCO
— UDP0807 —

Contrast Color Piping with Raglan Sleeve Cut

Anti-Bacterial & Anti-Odor Finishing



- * 100% Dri-Fit Polyester
- * Eyelet Weave
- * Matching Collar Rib
- * Moisture Wicking & Sweat Absorbent
- * Eco-Friendly & Water Saving

ULTIFRESH CONTRAST

VOV PIPING CREW NECK T-SHIRT

SIZE	CHEST	SLEEVE	LENGTH
2XS	34"	7"	25"
XS	36"	7.5"	26"
S	38"	8"	27"
M	40"	8.5"	28"
L	42"	9"	29"
XL	44"	9.5"	30"
2XL	46"	10"	31"
3XL	48"	10.5"	32"

Note: Size may varies +/-5% from the above mentioned chart.

* 170GSM | 5.01oz (UDP0801)

* 160GSM | 4.72oz (THE REST)

UDP08 COLORS SELECTION



UDP0801
WHITE + BLACK



UDP0802
BLACK + RED



UDP0807
DARK GREY + WHITE



UDP0813
ORANGE + BLACK



UDP0816
YELLOW + BLACK

ULTIFRESH CONTRAST

CS SASH POLO T-SHIRT (UNISEX)

UDF13

COLORS SELECTION



UDF1301
WHITE + GREEN
+ DARK GREY



UDF1302
BLACK + RED



UDF1306
LIGHT GREY +
WHITE + BLUE



UDF1307
DARK GREY +
WHITE + BLUE



Anti-Bacterial
& Anti-Odor
Finishing

Contrast
Side Panel



- * 100% Dri-Fit Polyester
- * Interlock Weave
- * Moisture Wicking & Sweat Absorbent
- * Eco-Friendly & Water Saving

SIZE	SHOULDER	CHEST	SLEEVE	LENGTH
2XS	15"	34"	7"	25"
XS	16"	36"	7.5"	26"
S	17"	38"	8"	27"
M	18"	40"	8.5"	28"
L	19"	42"	9"	29"
XL	20"	44"	9.5"	30"
2XL	21"	46"	10"	31"
3XL	22"	48"	10.5"	32"

Note: Size may varies +/-5% from the above mentioned chart.

* 160GSM | 5.64oz

ULTIFRESH 2019
MODEL: SANA K
— UDF1906 —

ULTIFRESH 2019
MODEL: ETIENNE
— UDF1930 —



Anti-Bacterial
& Anti-Odor
Finishing

Contrast
Shoulder Panel



- * 100% Dri-Fit Polyester
- * Interlock Weave
- * Moisture Wicking & Sweat Absorbent
- * Eco-Friendly & Water Saving

ULTIFRESH CONTRAST

T MAX POLO T-SHIRT (UNISEX)

SIZE	SHOULDER	CHEST	SLEEVE	LENGTH
2XS	15"	34"	7"	25"
XS	16"	36"	7.5"	26"
S	17"	38"	8"	27"
M	18"	40"	8.5"	28"
L	19"	42"	9"	29"
XL	20"	44"	9.5"	30"
2XL	21"	46"	10"	31"
3XL	22"	48"	10.5"	32"

Note: Size may varies +/-5% from the above mentioned chart.

* 160GSM | 5.64oz

UDF19 COLORS SELECTION



UDF1902
BLACK + RED



UDF1906
GREY + LIGHT BLUE



UDF1912
ROYAL BLUE + GREY



UDF1930
GREEN + WHITE



ULTIFRESH 2019
MODEL: FRANCO
UDF3301



ULTIFRESH CONTRAST

BI-CROSS POLO T-SHIRT (UNISEX)



- * 100% Dri-Fit Polyester
- * Interlock Weave
- * Moisture Wicking & Sweat Absorbent
- * Eco-Friendly & Water Saving

SIZE	SHOULDER	CHEST	SLEEVE	LENGTH
2XS	15"	34"	7"	25"
XS	16"	36"	7.5"	26"
S	17"	38"	8"	27"
M	18"	40"	8.5"	28"
L	19"	42"	9"	29"
XL	20"	44"	9.5"	30"
2XL	21"	46"	10"	31"
3XL	22"	48"	10.5"	32"

Note: Size may varies +/-5% from the above mentioned chart.

* 160GSM | 5.64oz



UDF33 COLORS SELECTION



UDF3301
WHITE + YELLOW



UDF3302
BLACK + RED



UDF3303
NAVY BLUE + WHITE



UDF3307
GREY + WHITE



UDF3313
ORANGE + WHITE



UDF3321
GREEN + WHITE

ULTIFRESH 2019
MODEL: FRANCO
— UDF3301 —

ULTIFRESH 2019
MODEL: MICHELLE
— UDF4307 —



UDF43

COLORS SELECTION



UDF4301
WHITE + YELLOW



UDF4302
BLACK + RED



UDF4303
NAVY BLUE + WHITE



UDF4307
GREY + WHITE



UDF4313
ORANGE + WHITE



UDF4321
GREEN + WHITE



ULTIFRESH CONTRAST

BI-CROSS POLO T-SHIRT (FEMALE)



- * 100% Dri-Fit Polyester
- * **FEMALE** Cutting
- * Interlock Weave
- * Moisture Wicking & Sweat Absorbent
- * Eco-Friendly & Water Saving

SIZE	SHOULDER	CHEST	SLEEVE	LENGTH
S	13"	32"	6"	22.5"
M	14"	34"	6.5"	23.5"
L	15"	36"	6.5"	24.5"
XL	16"	38"	7"	25.5"

Note: Size may varies +/-5% from the above mentioned chart.



ULTIFRESH 2019
MODEL: SANA K
UDF0918

ULTIFRESH 2019
MODEL: ETIENNE
UDF0902



- * 100% Dri-Fit Polyester
- * Matching Collar Rib
- * Moisture Wicking & Sweat Absorbent
- * Dual Bind Flat Knitted (Exclusive Fabric)
- * Eco-Friendly & Water Saving

ULTIFRESH BURST

HYPER ALPHA CREW NECK T-SHIRT

SIZE	SHOULDER	CHEST	SLEEVE	LENGTH
2XS	15"	34"	7"	25"
XS	16"	36"	7.5"	26"
S	17"	38"	8"	27"
M	18"	40"	8.5"	28"
L	19"	42"	9"	29"
XL	20"	44"	9.5"	30"
2XL	21"	46"	10"	31"
3XL	22"	48"	10.5"	32"

Note: Size may varies +/-5% from the above mentioned chart.
* 140GSM | 4.13oz

UDF09 COLORS SELECTION



UDF0902
BLACK + RED



UDF0903
DARK BLUE + ROYAL BLUE



UDF0907
DARK GREY + LIGHT GREY



UDF0918
GREEN + WHITE



UDF0931
BLACK + YELLOW



UD0932
BLACK+ NEON ORANGE

ULTIFRESH BURST

FREEDOM X POLO T-SHIRT (UNISEX)



ULTIFRESH 2019
MODEL: ETIENNE
— UDF1512 —

ULTIFRESH 2019
MODEL: SANA K
— UDF1502 —

UDF15 COLORS SELECTION



UDF1501
WHITE + RED



UDF1502
BLACK + RED



UDF1503
NAVY + ROYAL BLUE



UDF1512
ROYAL BLUE + GREY



- * 100% Dri-Fit Polyester
- * 3 Button Polo Design
- * Dual Bind Flat Knitted (Exclusive Fabric)
- * Moisture Wicking & Sweat Absorbent
- * Eco-Friendly & Water Saving

SIZE	SHOULDER	CHEST	SLEEVE	LENGTH
2XS	15"	34"	7"	25"
XS	16"	36"	7.5"	26"
S	17"	38"	8"	27"
M	18"	40"	8.5"	28"
L	19"	42"	9"	29"
XL	20"	44"	9.5"	30"
2XL	21"	46"	10"	31"
3XL	22"	48"	10.5"	32"
4XL	23"	50"	11"	33"

Note: Size may varies +/-5% from the above mentioned chart.

* 140GSM | 4.13oz





ULTIFRESH 2019
MODEL: FRANCO
— UDF2013 —

UDF20
COLORS SELECTION



UDF2001
WHITE + YELLOW



UDF2002
BLACK + RED



UDF2003
DARK BLUE + ROYAL BLUE



UDF2004
RED + BLACK



UDF2010
LIGHT BLUE + WHITE



UDF2013
ORANGE + WHITE



UDF2027
WHITE + RED

ULTIFRESH
ORIENTAL
ZIP UP COLLAR POLO T-SHIRT



- * 100% Dri-Fit Polyester
- * Interlock Weave
- * Contrast Piping
- * Moisture Wicking & Sweat Absorbent
- * Eco-Friendly & Water Saving

SIZE	SHOULDER	CHEST	SLEEVE	LENGTH
2XS	15"	34"	7"	25"
XS	16"	36"	7.5"	26"
S	17"	38"	8"	27"
M	18"	40"	8.5"	28"
L	19"	42"	9"	29"
XL	20"	44"	9.5"	30"
2XL	21"	46"	10"	31"
3XL	22"	48"	10.5"	32"
4XL	23"	50"	11"	33"

Note: Size may varies +/-5% from the above mentioned chart.
* 160GSM | 4.72oz





ULTIFRESH ORIENTAL ZIP UP COLLAR POLO T-SHIRT

SIZE	SHOULDER	CHEST	SLEEVE	LENGTH
S	13"	32"	6"	22.5"
M	14"	34"	6.5"	23.5"
L	15"	36"	6.5"	24.5"
XL	16"	38"	7"	25.5"

Note: Size may varies +/-5% from the above mentioned chart.
* 160GSM | 5.64oz

- * 100% Dri-Fit Polyester
- * Interlock Weave
- * **FEMALE** Cutting

- * Contrast Piping
- * Moisture Wicking & Sweat Absorbent
- * Eco-Friendly & Water Saving

UDF28 COLORS SELECTION



UDF2801
WHITE + YELLOW



UDF2802
BLACK + RED



UDF2803
DARK BLUE + ROYAL BLUE



UDF2804
RED + BLACK



UDF2810
LIGHT BLUE + WHITE



UDF2813
ORANGE + WHITE



UDF2827
WHITE + RED

ULTIFRESH HEATHER EDGE CREW NECK T-SHIRT

Anti-Bacterial
& Anti-Odor
Finishing

Edge Cut &
Sewn Design



ULTIFRESH 2019
MODEL: ETIENNE
— UDF1706 —

ULTIFRESH 2019
MODEL: SANA K
— UDF1710 —



UDF17
COLORS SELECTION

- * 47% Performance Polyester
- * 47% Melange Dri-Fit + 6% Spandex
- * Moisture Wicking & Sweat Absorbent
- * Eco-Friendly & Water Saving

SIZE	SHOULDER	CHEST	SLEEVE	LENGTH
2XS	15"	34"	7"	25"
XS	16"	36"	7.5"	26"
S	17"	38"	8"	27"
M	18"	40"	8.5"	28"
L	19"	42"	9"	29"
XL	20"	44"	9.5"	30"
2XL	21"	46"	10"	31"
3XL	22"	48"	10.5"	32"

Note: Size may varies +/-5% from the above mentioned chart.

* 170GSM | 5.01oz



UDF1702
ONYX BLACK



UDF1703
NAVY BLUE



UDF1706
LIGHT GREY



UDF1710
LIGHT BLUE



UDF1712
ROYAL BLUE



ULTIFRESH 2019
MODEL: MICHELLE
— UFS0106 —

ULTIFRESH 2019
MODEL: FRANCO
— USJ0102 —

SGS
TEST REPORT
Intertek
Total Quality. Assured.

Anti-Bacterial
& Anti-Odor
Finishing

Regular
Singlet Cut



- * 47% Performance Polyester
- * 47% Melange Dri-Fit + 6% Spandex
- * Moisture Wicking & Sweat Absorbent
- * Eco-Friendly & Water Saving

ULTIFRESH HEATHER

DRI-FIT SINGLET (UNISEX)

SIZE	SHOULDER	CHEST	LENGTH
XS	11.3"	36"	23.5"
S	11.6"	38"	24.5"
M	11.8"	40"	25.5"
L	12"	42"	26.5"
XL	12.3"	44"	27.5"
2XL	12.6"	46"	28.5"
3XL	12.8"	48"	29.5"

Note: Size may varies +/-5% from the above mentioned chart.

* 170GSM | 5.01oz

USJ01

COLORS SELECTION



USJ0102
ONYX BLACK



USJ0103
NAVY BLUE



USJ0106
LIGHT GREY



USJ0110
LIGHT BLUE



USJ0112
ROYAL BLUE



ULTIFRESH 2019
MODEL: MICHELLE
— UFS0106 —



ULTIFRESH HEATHER

DRI-FIT SINGLET (FEMALE)

SIZE	SHOULDER	CHEST	LENGTH
XS	10.6"	34"	22"
S	10.8"	36"	23"
M	11"	38"	24"
L	11.2"	40"	25"

Note: Size may varies +/-5% from the above mentioned chart.

* 170GSM | 5.01oz

- * 47% Performance Polyester
- * 47% Melange Dri-Fit + 6% Spandex
- * Moisture Wicking & Sweat Absorbent
- * Eco-Friendly & Water Saving

UFS01

COLORS SELECTION



UFS0102
ONYX BLACK



UFS0103
NAVY BLUE



UFS0106
LIGHT GREY



UFS0110
LIGHT BLUE



UFS0112
ROYAL BLUE

SGS
TEST REPORT

intertek
Total Quality. Assured.

ULTIFRESH 2019
MODEL: MICHELLE
— UCP1129 —

ULTIFRESH 2019
MODEL: FRANCO
— UCP1101 —



BACK VIEW

FRONT VIEW

- * 50% Polyester + 50% Cotton
- * Outer Polyester + Inner Cotton
- * Moisture Wicking & Sweat Absorbent
- * Eco-Friendly & Water Saving

ULTIFRESH HYBRID

MINIMALIST POLO T-SHIRT (UNISEX)

SIZE	SHOULDER	CHEST	SLEEVE	LENGTH
2XS	15"	34"	7"	25"
XS	16"	36"	7.5"	26"
S	17"	38"	8"	27"
M	18"	40"	8.5"	28"
L	19"	42"	9"	29"
XL	20"	44"	9.5"	30"
2XL	21"	46"	10"	31"
3XL	22"	48"	10.5"	32"

Note: Size may varies +/-5% from the above mentioned chart.
* 180GSM | 6.35oz.

UCP11 COLORS SELECTION



UCP1101
WHITE + BLACK



UCP1102
BLACK + WHITE



UCP1103
NAVY + WHITE



UCP1129
BLACK + GOLD

ULTIFRESH HYBRID

CONTRA POLO T-SHIRT (UNISEX)



- * 50% Polyester + 50% Cotton
- * Outer Polyester + Inner Cotton
- * Moisture Wicking & Sweat Absorbent
- * Eco-Friendly & Water Saving

SIZE	SHOULDER	CHEST	SLEEVE	LENGTH
2XS	15"	34"	7"	25"
XS	16"	36"	7.5"	26"
S	17"	38"	8"	27"
M	18"	40"	8.5"	28"
L	19"	42"	9"	29"
XL	20"	44"	9.5"	30"
2XL	21"	46"	10"	31"
3XL	22"	48"	10.5"	32"

Note: Size may varies +/-5% from the above mentioned chart.
* 190GSM | 6.70oz



UCP13

COLORS SELECTION



UCP1301
WHITE + GREY



UCP1307
GREY + RED



UCP1310
LIGHT BLUE + WHITE



UCP1334
WHITE + GREEN



UCP1335
WHITE + LIGHT BLUE

ULTIFRESH 2019
MODEL: MICHELLE
UCP2310



ULTIFRESH HYBRID

CONTRA POLO T-SHIRT (FEMALE)

SIZE	SHOULDER	CHEST	SLEEVE	LENGTH
S	13"	32"	6"	22.5"
M	14"	34"	6.5"	23.5"
L	15"	36"	6.5"	24.5"
XL	16"	38"	7"	25.5"

Note: Size may varies +/-5% from the above mentioned chart.

* 190GSM | 6.70oz

- * 50% Polyester + 50% Cotton
- * **FEMALE** Cutting
- * Outer Polyester + Inner Cotton

- * Moisture Wicking & Sweat Absorbent
- * Eco-Friendly & Water Saving

UCP23 COLORS SELECTION



UCP2301
WHITE + GREY



UCP2307
GREY + RED



UCP2310
LIGHT BLUE + WHITE



UCP2334
WHITE + GREEN



UCP2335
WHITE + LIGHT BLUE



ULTIFRESH 2019
MODEL: ETIENNE
UH0212

UH02

COLORS SELECTION



UH0202
BLACK



UH0206
LIGHT GREY



UH0207
DARK GREY



UH0212
NAVY BLUE

ULTIFRESH PIOQUE

FD TWIN TIPPED POLO T-SHIRT (UNISEX)

Anti-Bacterial
& Anti-Odor
Finishing

Double
Pique Knit



BACK
VIEW

FRONT
VIEW

- * 60% Polyester + 40% Cotton
- * Dual Stripe Design
- * Moisture Wicking & Sweat Absorbent
- * Eco-Friendly & Water Saving

SIZE	SHOULDER	CHEST	SLEEVE	LENGTH
2XS	15"	34"	7"	25"
XS	16"	36"	7.5"	26"
S	17"	38"	8"	27"
M	18"	40"	8.5"	28"
L	19"	42"	9"	29"
XL	20"	44"	9.5"	30"
2XL	21"	46"	10"	31"
3XL	22"	48"	10.5"	32"
4XL	23"	50"	11"	33"

Note: Size may varies +/-5% from the above mentioned chart.

* 220GSM | 7.76oz





ULTIFRESH 2019
MODEL: SANA K
UDF1206



ULTIFRESH PIOQUE

FD TWIN TIPPED POLO T-SHIRT (FEMALE)

SIZE	SHOULDER	CHEST	SLEEVE	LENGTH
S	13"	32"	6"	22.5"
M	14"	34"	6.5"	23.5"
L	15"	36"	6.5"	24.5"
XL	16"	38"	7"	25.5"

Note: Size may varies +/-5% from the above mentioned chart.

* 220GSM | 7.76oz

- * 60% Polyester + 40% Cotton
- * **FEMALE** Cutting
- * Dual Stripe Design
- * Moisture Wicking & Sweat Absorbent
- * Eco-Friendly & Water Saving

UH12 COLORS SELECTION



UH1202
BLACK



UH1206
LIGHT GREY



UH1207
DARK GREY



UH1212
NAVY BLUE

ULTIFRESH 2019
MODEL: SANA K
UH0330

ULTIFRESH 2019
MODEL: ETIENNE
UH0302



Anti-Bacterial
& Anti-Odor
Finishing

Contrast
Mandarin
Collar Design



BACK
VIEW

FRONT
VIEW

- * 60% Polyester + 40% Cotton
- * Double Pique Knit
- * Dual Stripe Design
- * Moisture Wicking & Sweat Absorbent
- * Eco-Friendly & Water Saving

ULTIFRESH PIOQUE

ACE COLLAR POLO T-SHIRT (UNISEX)

SIZE	SHOULDER	CHEST	SLEEVE	LENGTH
2XS	15"	34"	7"	25"
XS	16"	36"	7.5"	26"
S	17"	38"	8"	27"
M	18"	40"	8.5"	28"
L	19"	42"	9"	29"
XL	20"	44"	9.5"	30"
2XL	21"	46"	10"	31"
3XL	22"	48"	10.5"	32"

Note: Size may varies +/-5% from the above mentioned chart.
* 220GSM | 7.76oz

UH03 COLORS SELECTION



UH0301
WHITE + NAVY + RED



UH0302
BLACK + GREY + RED



UH0307
NAVY + GREY + RED



UH0330
LIGHT GREY + BLACK + RED



ULTIFRESH 2019
MODEL: FRANCO
— UVJ0120 —



ULTIFRESH 2019
MODEL: MICHELLE
— UVJ0128 —

Anti-Bacterial
& Anti-Odor
Finishing

Matching
Collar Rib



ULTIFRESH BOMBER

ZIP UP JACKET (UNISEX)

SIZE	SHOULDER	CHEST	SLEEVE	LENGTH
2XS	16"	37"	21.5"	25"
XS	17"	39"	22.5"	26"
S	18"	41"	23.5"	27"
M	18.5"	43"	24"	28"
L	19"	45"	25"	29"
XL	20"	47"	25.5"	30"
2XL	21"	49"	26.5"	31"
3XL	22"	51"	27"	32"
4XL	23"	53"	27.5"	33"

- * 100% Performance Dri-Fit Polyester
- * 100% Polyester Inner Lining
- * Moisture Wickig & Sweat Absorbent
- * Eco-Friendly & Water Saving

Note: Size may varies +/-5% from the above mentioned chart.

* SHELL - 55GSM | 1.94oz

* INNER - 160GSM | 5.64oz

UVJ01

COLORS SELECTION



UVJ0102
BLACK



UVJ0103
NAVY



UVJ0105
MAROON



UVJ0120
OLIVE



UVJ0128
ORANGE

SGS
TEST REPORT

Intertek
Total Quality Assured.

ULTIFRESH 2019
MODEL: SANA K
— UVJ0307 —



ULTIFRESH 2019
MODEL: ETIENNE
— UVJ0303 —



- * 92% Polyester + 8% Spandex
- * Side Zip Pocket
- * Matching Collar Rib
- * Moisture Wicking & Sweat Absorbent
- * Eco-Friendly & Water Saving

ULTIFRESH FULL MOON

ZIP UP JACKET (UNISEX)

SIZE	SHOULDER	CHEST	SLEEVE	LENGTH
2XS	16"	37"	21.5"	25"
XS	17"	39"	22.5"	26"
S	18"	41"	23.5"	27"
M	18.5"	43"	24"	28"
L	19"	45"	25"	29"
XL	20"	47"	25.5"	30"
2XL	21"	49"	26.5"	31"
3XL	22"	51"	27"	32"
4XL	23"	53"	27.5"	33"

Note: Size may varies +/-5% from the above mentioned chart.

* 280GSM | 8.26oz

UVJ03 COLORS SELECTION



UVJ0302
BLACK



UVJ0303
NAVY



UVJ0307
LIGHT GREY

ULTIFRESH 2019
MODEL: ETIENNE
— UVJ0512 —

ULTIFRESH 2019
MODEL: SANA K
— UVJ0526 —



Anti-Bacterial
& Anti-Odor
Finishing

Double Striped Rib
(Sleeve, Collar & Hem)



- * 92% Polyester + 8% Spandex
- * Color Matching Matt Button
- * 2 Front Pockets
- * Moisture Wicking & Sweat Absorbent
- * Eco-Friendly & Water Saving

ULTIFRESH VARSITY JACKET

SIZE	SHOULDER	CHEST	SLEEVE	LENGTH
2XS	16"	37"	22"	23.5"
XS	17"	39"	22.5"	24.5"
S	18"	41"	23.5"	25.5"
M	18.5"	43"	24"	26.5"
L	19.5"	45"	25"	27.5"
XL	20"	47"	25.5"	28.5"
2XL	21"	49"	26.5"	29.5"
3XL	22"	51"	27.5"	30.5"
4XL	23"	53"	28"	31.5"

Note: Size may varies +/-5% from the above mentioned chart.

* 280GSM | 8.26oz

UVJ05 COLORS SELECTION



UVJ0502
BLACK + WHITE



UVJ0503
NAVY BLUE + WHITE



UVJ0504
CRIMSON RED + WHITE



UVJ0512
ROYAL BLUE + WHITE



UVJ0526
BLACK + RED

READY STOCK ESSENTIALS

MINIMALISM
IS NOT A STYLE,
IT IS AN ATTITUDE,
A WAY OF BEING.

C. SILVESTRIN

**COLLAR FLEECE
ZIP UP JACKET (UNISEX)**



ULTIFRESH 2019
MODEL: FRANCO
— OWC4512 —



SIZE	WAIST	CHEST	SLEEVE	LENGTH
S	43"	42"	23"	25"
M	44"	44"	24"	26"
L	46"	45"	25"	26"
XL	47"	47"	26"	27"
2XL	49"	48"	26"	28"
3XL	50"	50"	27"	29"

Note: Size may varies +/-5% from the above mentioned chart.

* 280GSM | 8.20oz

- **100% Polyester Reverse Dual Sided Fleece**
- **Full Zip Stand Up Collar**
- **Elastic Sleeve End**
- **Zip On Both Sided Pocket**
- **Elastic Cord At Hem For Hem Adjustment**

OWC45
COLORS SELECTION



OWC4502
ONYX BLACK



OWC4504
CRIMSON RED



OWC4512
ROYAL BLUE

READY STOCK
ESSENTIALS



ULTIFRESH 2019
MODEL: MICHELLE
— OWC5504 —

READY STOCK
ESSENTIALS

BEAM
QUALITY APPAREL
COLLAR FLEECE
ZIP UP JACKET (FEMALE)



SIZE	WAIST	CHEST	SLEEVE	LENGTH
S	37"	35"	22"	23"
M	39"	36"	23"	24"
L	40"	38"	23"	25"
XL	42"	39"	24"	26"
2XL	43"	41"	24"	26"
3XL	45"	43"	25"	27"

Note: Size may varies +/-5% from the above mentioned chart.

* 280GSM | 8.20oz

- **100% Polyester Reverse Dual Sided Fleece**
- **FEMALE** Cutting
- Full Zip Stand Up Collar
- Elastic Sleeve End
- Zip On Both Sided Pocket
- Elastic Cord At Hem For Hem Adjustment

OWC55
COLORS SELECTION



OWC5502
ONYX BLACK



OWC5504
CRIMSON RED



OWC5512
ROYAL BLUE



ULTIFRESH 2019
MODEL: ETIENNE
— HDR3004 —

READY STOCK
ESSENTIALS

Unlined Hood With
Matching Drawstring



- Polyester / Cotton Blend
- Kangaroo Pockets With Ribbed Finishing
- Double Needle Cuffs And Waistband For Extra Durability.

BEAM
QUALITY APPAREL
**HOODIE
WITHOUT ZIP**

SIZE	SHOULDER	CHEST	SLEEVE	LENGTH
2XS	15"	34"	23"	25"
XS	16"	36"	24.5"	25.5"
S	17"	38"	24.5"	26"
M	18"	41"	25"	27.5"
L	18.5"	43"	26"	29"
XL	19"	46"	27"	30"
2XL	20"	48"	27.5"	31"
3XL	21"	50"	28"	32"
4XL	21.5"	52"	29"	33"

Note: Size may varies +/-5% from the above mentioned chart.
* 220GSM | 6.50oz

HDR30
COLORS SELECTION



HDR3001
PEARL WHITE



HDR3002
ONYX BLACK



HDR3003
NAVY BLUE



HDR3004
CRIMSON RED



HDR3006
LIGHT GREY



ULTIFRESH 2019
MODEL: FRANCO
HDR4002

READY STOCK
ESSENTIALS

Unlined Hood With
Matching Drawstring



- Polyester / Cotton Blend
- Pouch Pockets
- Matching Zip
- Double Needle Cuffs And Waistband For Extra Durability

BEAM
QUALITY APPAREL
**HOODIE
WITH ZIP**

SIZE	SHOULDER	CHEST	SLEEVE	LENGTH
2XS	15"	34"	23"	25"
XS	16"	36"	24.5"	25.5"
S	17"	38"	24.5"	26"
M	18"	41"	25"	27.5"
L	18.5"	43"	26"	29"
XL	19"	46"	27"	30"
2XL	20"	48"	27.5"	31"
3XL	21"	50"	28"	32"
4XL	21.5"	52"	29"	33"

Note: Size may varies +/-5% from the above mentioned chart.
* 220GSM | 6.50oz

HDR40
COLORS SELECTION



HDR4001
PEARL WHITE



HDR4002
ONYX BLACK



HDR4003
NAVY BLUE



HDR4004
CRIMSON RED



HDR4006
LIGHT GREY

ULTIFRESH 2019
MODEL: FRANCO
— AKJ0102 —



ULTIFRESH 2019
MODEL: MICHELLE
— AKJ0104 —



READY STOCK
ESSENTIALS



Unique printed patterns

- 100% Light Weight Polyester
- UPF40 + Coating
- Fully Sewn Built In Hoodie Design
- Packable Drawstring Bag Included
- Come with Unique Pattern Prints in Front Panel

Note: Size may varies +/-5% from the above mentioned chart.

BEAM
QUALITY APPAREL
**LIGHTWEIGHT
MICROFIBER
JACKET IN A BAG (PACKABLE)**

SIZE	CHEST	SLEEVE	LENGTH
S	40"	27.5"	25"
M	41"	28.5"	26"
L	43"	29"	26.5"
XL	44"	30"	27"
2XL	46"	31"	28"
3XL	48"	31.5"	29"
4XL	49"	32.5"	29.5"

AKJ01
COLORS SELECTION



AKJ0101
BLACK



AKJ0102
ROYAL BLUE



AKJ0103
LIME GREEN



AKJ0104
ORANGE



AKJ0105
YELLOW



AKJ0106
SKY BLUE



AKJ0107
RED



AKJ0108
BRIGHT PINK



AKJ0110
PINK



AKJ0111
WHITE

**CLASSIC
SOFT CARDIGAN**



SIZE	SHOULDER	CHEST	SLEEVE	LENGTH
S	17"	38"	8"	27"
M	18"	40"	8.5"	28"
L	19"	42"	9"	29"
XL	20"	44"	9.5"	30"
2XL	21"	46"	10"	31"
3XL	22"	48"	10.5"	32"
5XL	24"	52"	11.5"	34"

Note: Size may varies +/-5% from the above mentioned chart.

* 130GSM | 8.88oz

ULTIFRESH 2019
MODEL: SANA K
— ARC1006 —

ULTIFRESH 2019
MODEL: ETIENNE
— ARC1001 —

ARC10
COLORS SELECTION



ARC1001
DARK GREY



ARC1002
NAVY BLUE



ARC1003
GREEN



ARC1004
BLACK



ARC1005
BROWN



ARC1006
MAROON

READY STOCK
ESSENTIALS



ULTIFRESH 2019
MODEL: FRANCO
ARS1005

READY STOCK
ESSENTIALS

BEAM
QUALITY APPAREL
**CLASSIC
V-NECK SWEATER**



- * Matching Rib
- * 100% Cotton
- * Fitted Cut

SIZE	SHOULDER	CHEST	SLEEVE	LENGTH
S	17"	38"	8"	27"
M	18"	40"	8.5"	28"
L	19"	42"	9"	29"
XL	20"	44"	9.5"	30"
2XL	21"	46"	10"	31"
3XL	22"	48"	10.5"	32"
5XL	24"	52"	11.5"	34"

Note: Size may varies +/-5% from the above mentioned chart.

* 130GSM | 8.88oz

ARS10
COLORS SELECTION



ARS1001
DARK GREY



ARS1002
NAVY BLUE



ARS1003
GREEN



ARS1004
BLACK



ARS1005
BROWN



ARS1006
MAROON



ULTIFRESH 2019
MODEL: SANA K
UPT01-05



ULTIFRESH 2019
MODEL: ETIENNE
UPT01-40

READY STOCK
ESSENTIALS

**POLO T-SHIRT
(UNISEX)**

- **100% Premium "LACOSTE" Fabric**
- **Matching Color Button**
- **Matching Ribbed Collar & Cuffs**
- **Available In 15 Colors**
- **XS - 3XL Size**
- **All Ready Stock**

SIZE	SHOULDER	CHEST	SLEEVE	LENGTH
XS	15"	36"	8"	26"
S	16"	38"	8.5"	27"
M	18"	40"	8.5"	28"
L	18"	41"	9"	29"
XL	19"	42"	9"	30"
2XL	20"	44"	9.5"	30.5"
3XL	21"	48"	9.5"	31"

Note: Size may varies +/-5% from the above mentioned chart.
* 220GSM



UPT01
COLORS SELECTION



ULTIFRESH 2019
MODEL: FRANCO
USS01-05



ULTIFRESH 2019
MODEL: MICHELLE
USS01-17



READY STOCK
ESSENTIALS

**SHORT SLEEVE
T-SHIRT (UNISEX)**

- 100% Premium Cotton (Unisex)
- Matching Ribbed Collar
- Available In 18 Colors
- XS - 5XL Size
- All Ready Stock

SIZE	SHOULDER	CHEST	SLEEVE	LENGTH
XS	15"	36"	7"	26"
S	17"	38"	7.5"	27"
M	18"	40"	7.5"	28"
L	19"	42"	8"	29"
XL	20"	44"	8"	30"
2XL	20.5"	46"	8.5"	31"
3XL	22"	48"	8.5"	31.5"
4XL	23"	50"	9"	32"
5XL	24"	52"	9.5"	33"

Note: Size may varies +/-5% from the above mentioned chart.

* 170GSM - 175GSM



USS01
COLORS SELECTION



BEAM

QUALITY APPAREL

SHORT SLEEVE T-SHIRT (KIDS)

- **100% Premium Cotton**
- **Matching Ribbed Collar**
- **Available In 15 Colors**
- **2/4 years - 13/14 years**
- **All Ready Stock**

SIZE	SHOULDER	CHEST	SLEEVE	LENGTH
2- 4	11"	24"	5"	17"
5 - 6	12"	26"	6"	18"
7 - 8	13"	28"	6.5"	20"
9 - 10	15"	30"	6.5"	21"
11 - 12	15"	34"	7"	23"
13 - 14	17"	36"	7"	24"

Note: Size may varies +/-5% from the above mentioned chart.

* 170GSM - 175GSM



KSS01

COLORS SELECTION



KSS01-01
WHITE



KSS01-02
BLACK



KSS01-03
NAVY BLUE



KSS01-05
MAROON



KSS01-12
ROYAL BLUE



KSS01-13
ORANGE



KSS01-17
YELLOW



KSS01-18
LIME GREEN



KSS01-23
PURPLE



KSS01-39
INDIGO BLUE



KSS01-40
BOTTLE GREEN



KSS01-41
OLIVE



KSS01-44
AQUA



KSS01-45
FUSCHIA



KSS01-46
KELLY GREEN

BEAM

QUALITY APPAREL

APRON

100% POLYESTER

- **100% Polyester**
- **Back Lace Design**
- **Front Pockets**
- **Customizable**
- **Available In 10 Colors**
- **Free Size**
- **All Ready Stock**

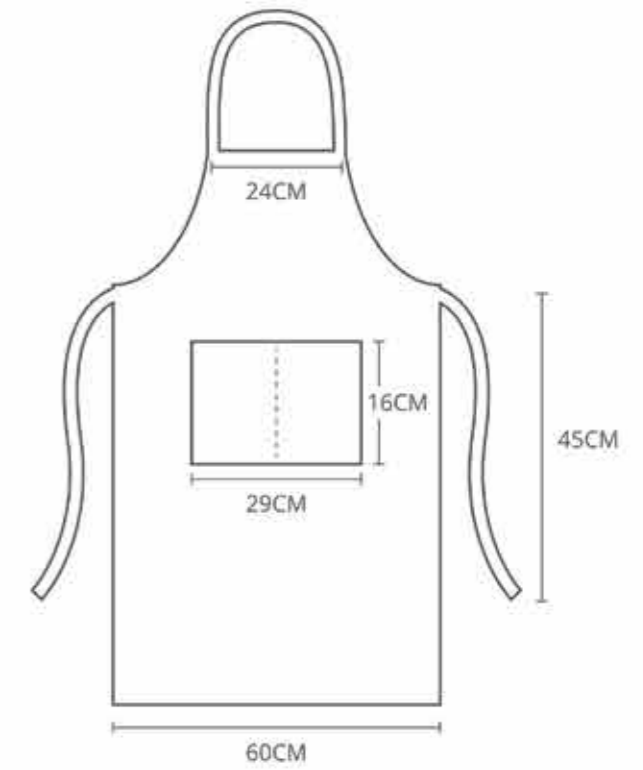

Note: dimension may vary +/- 5% from the above mentioned chart.

APR10

COLORS SELECTION



APR101
BURGUNDY



APR102
ORANGE



APR103
PEARL WHITE



APR104
SKY BLUE



APR105
LIME GREEN



APR106
ROSE PINK



APR107
YELLOW



APR108
BLACK



APR109
COFFEE



APR110
RED



ULTIFRESH 2019
MODEL: FRANCO
RGN2101

READY STOCK
ESSENTIALS

**CREW NECK
LONG SLEEVE**



- Poly/Cotton Blend
- Crew Neck, Long Sleeve Design
- 6 Available Colors
- Double needle cuffs and waistband for extra durability

SIZE	SHOULDER	CHEST	LENGTH
XXS	15"	34"	25"
XS	16"	36"	26"
S	17"	39"	26"
M	18"	41"	28"
L	19"	43"	29"
XL	19"	46"	30"
2XL	20"	48"	31"
3XL	21"	50"	32"
4XL	22"	53"	33"

Note: Size may varies +/-5% from the above mentioned chart.
* 220GSM | 6.50oz

RGN21
COLORS SELECTION



RGN2101
PEARL WHITE



RGN2102
ONXY BLACK



RGN2103
NAVY BLUE



RGN2104
CRIMSON RED



RGN2106
LIGHT GREY



RGN2138
LIGHT PINK



CORPORATE SHIRT
Quality Apparels

BEAM
QUALITY APPAREL

**OXFORD
CORPORATE
SHIRT**



- Made of 60% Cotton 40% Oxford Fabric
- Hidden Buttons Behind Collar For An Alternate Look.
- One Chest Pocket On The Left
- Off White Full Placket Buttons

SIZE	SHOULDER	CHEST	SLEEVE	LENGTH
S(38)	17"	38"	24"	28"
M(39)	17"	39"	24"	29"
L(40)	18"	41"	25"	30"
XL(41)	19"	43"	25"	30"
2XL(42)	19"	44"	25"	30"
3XL(43)	20"	47"	25"	31"
4XL(44)	20"	49"	25"	31"

Note: Size may varies +/-5% from the above mentioned chart.

FTL3

COLORS SELECTION



FTL301
PEARL WHITE



FTL303
NAVY BLUE



FTL306
LIGHT GREY



FTL310
LIGHT BLUE



FTL338
LIGHT PINK



FTL340
LAKE BLUE

ULTIFRESH 2019
MODEL: ETIENNE
ACS110

ULTIFRESH 2019
MODEL: SANA K
FTL138



Black piping available for
ACS 108 & ACS 109
Only



BEAM
QUALITY APPAREL
**HIGHT QUALITY
CORPORATE
UNISEX SHIRT**

SIZE	SHOULDER	CHEST	SLEEVE	LENGTH
S(38)	16.5"	37"	23"	28"
M(39)	17"	38"	23"	28"
L(40)	18"	39"	23.5"	28.5"
XL(41)	18"	41"	24"	29"
2XL(42)	18.5"	43"	24"	30"
3XL(43)	19.5"	44"	24.5"	31"
4XL(44)	20.5"	47"	25"	32"

Note: Size may varies +/-5% from the above mentioned chart.
* 220GSM | 6.50oz.

- 40% Cotton + 60% Polyester Fabric
- Moisture Wick & Anti Wrinkle Technology
- V-Edge Collar Design with Iron Fusing
- Full Placket Buttons
- One Chest Pocket On The Left
- With Poplin / With Twill Finishing

ACS10 /11
COLORS SELECTION

POPLIN FINISHING



ACS110
MAROON RED



ACS111
BLACK



ACS112
LIGHT PINK



ACS113
LIGHT BLUE



ACS114
WHITE

TWILL FINISHING



ACS100
WHITE



ACS102
BLACK



ACS103
LIGHT BLUE



ACS107
LIGHT PURPLE



ACS108
LIGHT BLUE



ACS109
WHITE

READY STOCK
ESSENTIALS

ULTIFRESH 2019
MODEL: ETIENNE
TCS101



TWILL FINISHING - UNISEX SHORT SLEEVE

SIZE	SHOULDER	CHEST	SLEEVE	LENGTH
S(38)	16.5"	37"	8"	28"
M(39)	17"	38"	8"	28"
L(40)	18"	39"	8.5"	28.5"
XL(41)	18"	41"	8.5"	29"
2XL(42)	18.5"	43"	9"	30"
3XL(43)	19.5"	44"	9"	31"
4XL(44)	20.5"	47"	9.5"	32"

Note: Size may varies +/-5% from the above mentioned chart.

TCS1
COLORS SELECTION



TCS 101
WHITE



TCS 102
BLACK



TCS 110
LIGHT BLUE



TCS 138
PINK



TCS 123
PURPLE



TCS 110(A)
LIGHT BLUE
(CHECKERED)

BEAM
QUALITY APPAREL



READY STOCK
ESSENTIALS

TWILL FINISHING - FEMALE CUT SHORT SLEEVE

SIZE	SHOULDER	CHEST	SLEEVE	LENGTH
XS(35)	14.5"	35"	7.5"	22.5"
S(36)	15"	37"	7.5"	23"
M(37)	15.5"	38"	7.5"	23.5"
L(38)	16"	40"	8"	24"
XL(39)	16"	41"	8"	25"
2XL(40)	16.5"	42"	8.5"	25.5"
3XL(41)	17"	44"	8.5"	26"
5XL(42)	17.5"	47"	9"	27"

Note: Size may varies +/-5% from the above mentioned chart.



FTS 101
WHITE



FTS 102
BLACK



FTS 110
LIGHT BLUE

TWILL FINISHING - FEMALE CUT LONG SLEEVE

SIZE	SHOULDER	CHEST	SLEEVE	LENGTH
XS(35)	14.5"	35"	21"	22.5"
S(36)	15"	37"	21"	23"
M(37)	15.5"	38"	21.5"	23.5"
L(38)	16"	40"	21.5"	24"
XL(39)	16"	41"	22"	25"
2XL(40)	16.5"	42"	22.5"	25.5"
3XL(41)	17"	44"	23"	26"
5XL(42)	17.5"	47"	23.5"	27"

Note: Size may varies +/-5% from the above mentioned chart.



FTL 101
WHITE



FTL 110
LIGHT BLUE



FTL 138
PINK



ULTIFRESH 2019
MODEL: ETIENNE
CBM3503

PAT0103

READY STOCK
ESSENTIALS



CBM3502
BLACK

CBM3503
NAVY BLUE

- 65% Polyester 35% Rayon
- (Shell) 100% Polyester
- 3 Pocket Flat Collar Design
- Full Suit Available
- Dual Buttons

PREMIUM

**2 BUTTON FITTED BLAZER
(MALE CUTTING)**

JACKET SIZE CHART

SIZE	SHOULDER	CHEST	SLEEVE	LENGTH
165/S	16.75"	37.8"	23.2"	25.6"
170/M	17.2"	39.4"	23.8"	26.4"
175/L	17.7"	41"	24.4"	27"
180/XL	18.2"	42.5"	24.8"	28"
185/2XL	18.6"	44"	25.4"	28.7"
190/3XL	19"	45.6"	26"	29.5"
195/4XL	19.6"	47.2"	26.5"	30.3"

Note: Size may varies +/-5% from the above mentioned chart.



PAT0102
BLACK

PAT0103
NAVY BLUE

PANT SIZE CHART

SIZE	WAIST	HIP	LENGTH
165/S	29"	36.2"	39.3"
170/M	30"	37.4"	40"
175/L	31.5"	38.5"	41"
180/XL	32.6"	40"	41.7"
185/2XL	34"	41.3"	42.5"
190/3XL	35.8"	43"	42.5"
195/4XL	37.4"	44.5"	42.5"

Note: Size may varies +/-5% from the above mentioned chart.





ULTIFRESH 2019
MODEL: SANA K
CBM2503

SKT0202

READY STOCK
ESSENTIALS



CBM2502
BLACK

CBM2503
NAVY BLUE

- 65% Polyester 35% Rayon
- (Shell) 100% Polyester
- 3 Pocket Flat Collar Design
- Full Suit Available
- Dual Buttons

PREMIUM

**2 BUTTON FITTED BLAZER
(FEMALE CUTTING)**

JACKET SIZE CHART

SIZE	SHOULDER	CHEST	SLEEVE	LENGTH
155/XS	14"	33"	22"	21.8"
160/S	14.5"	34.6"	22"	21.8"
165/M	15"	36"	22.4"	22.6"
170/L	15.3"	37.8"	22.8"	23.4"
175/XL	15.7"	39.4"	23.2"	24.2"
180/2XL	16"	41"	23.6"	25"
185/3XL	16.5"	42.5"	23.6"	25"
190/4XL	17"	44"	23.6"	25"

Note: Size may varies +/-5% from the above mentioned chart.



SKT0202
BLACK

SKT0203
NAVY BLUE

SKIRT SIZE CHART

SIZE	WAIST	HIP	LENGTH
155/XS	24.8"	33"	18"
160/S	26.3"	34.6"	18.3"
165/M	27.5"	36.2"	18.5"
170/L	29"	37.8"	18.7"
175/XL	30"	39.3"	19"
180/2XL	32.2"	41"	19"
185/3XL	33.8"	42.5"	19.3"
190/4XL	35.4"	44"	19.3"

Note: Size may varies +/-5% from the above mentioned chart.



Classic Button Down
Back Pocket

Elastic Waist Band
Design



CUSTOMIZATION
WITH ULTIFRESH TECHNOLOGY



ULTIFRESH CUSTOMIZATION

Create your very own anti-bacterial & anti-odor apparels from scratch with 8-steps customization process! A perfect alternative for brands or institution who wish to incorporate our unique technology to their new or existing apparels design.

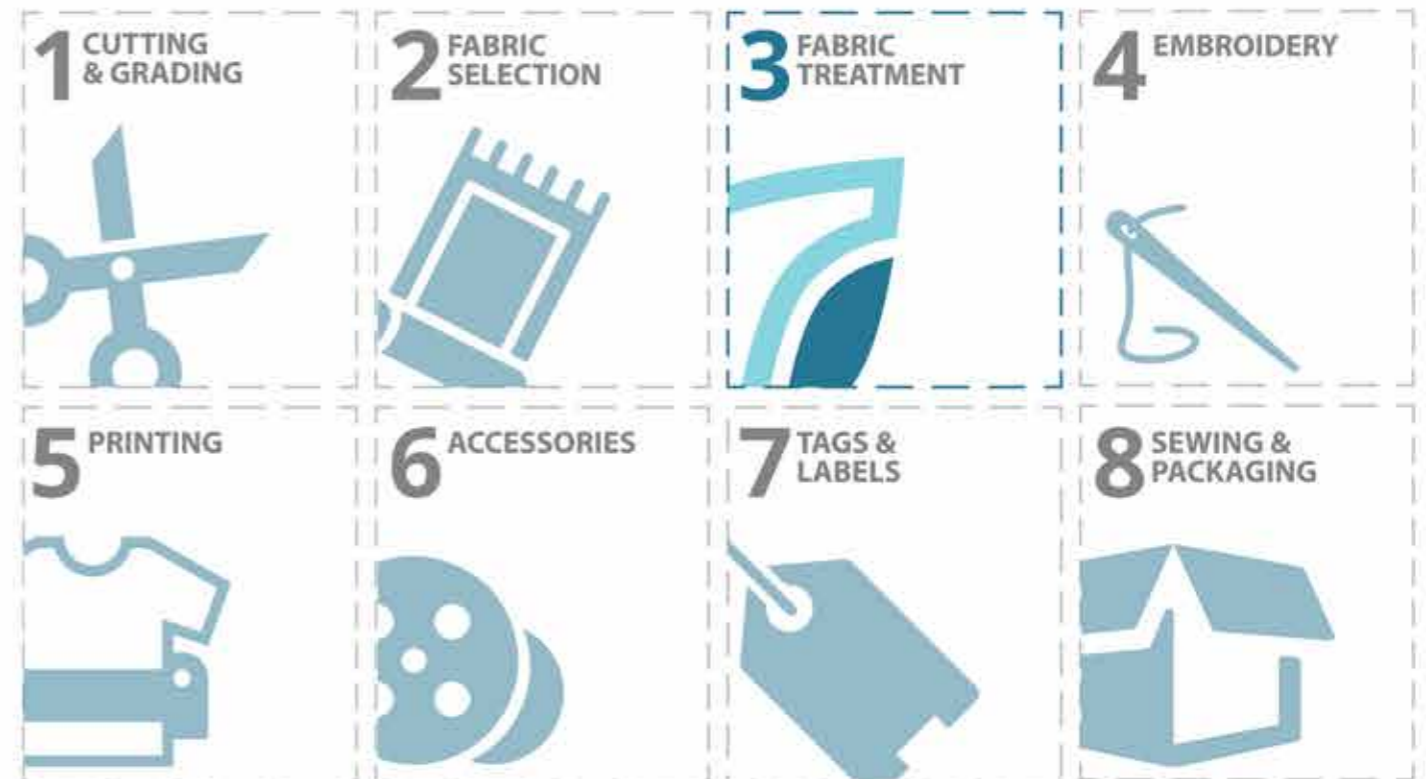

STYLES: POLO T-SHIRT



STYLES: POLO T-SHIRT



STYLES: SLEEVES

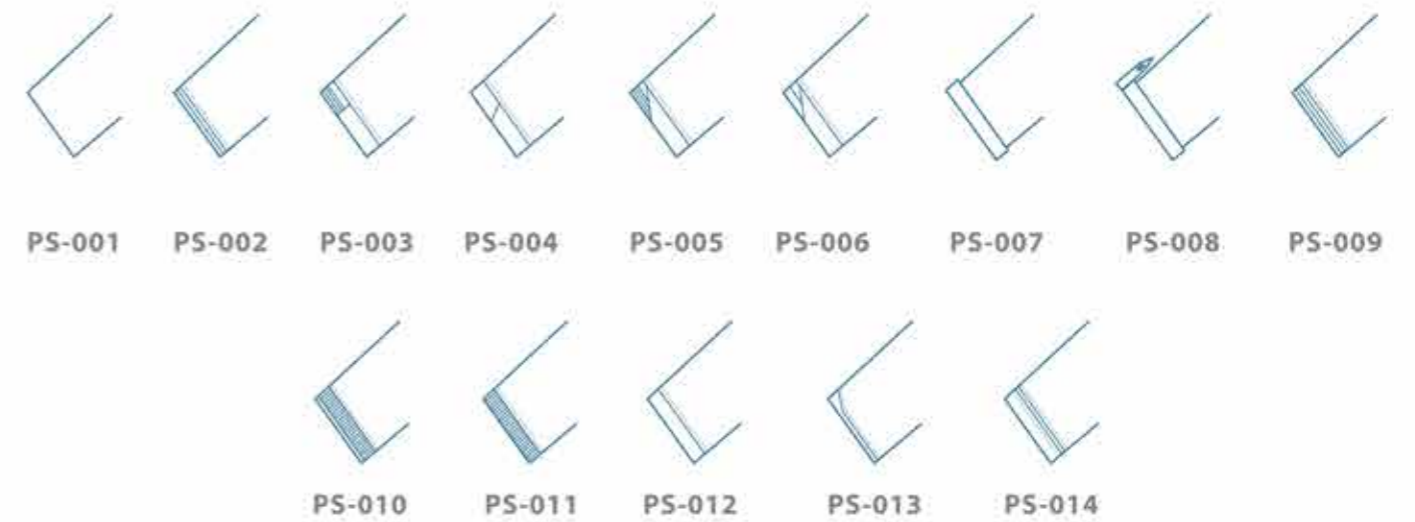

STYLES: COLLAR

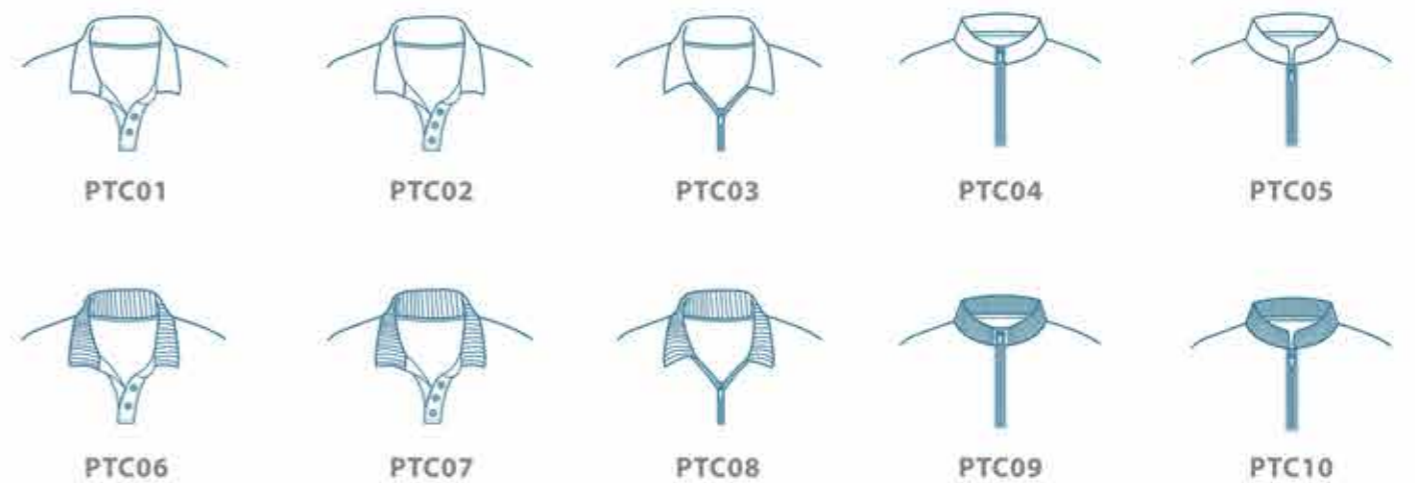

STYLES: POCKETS

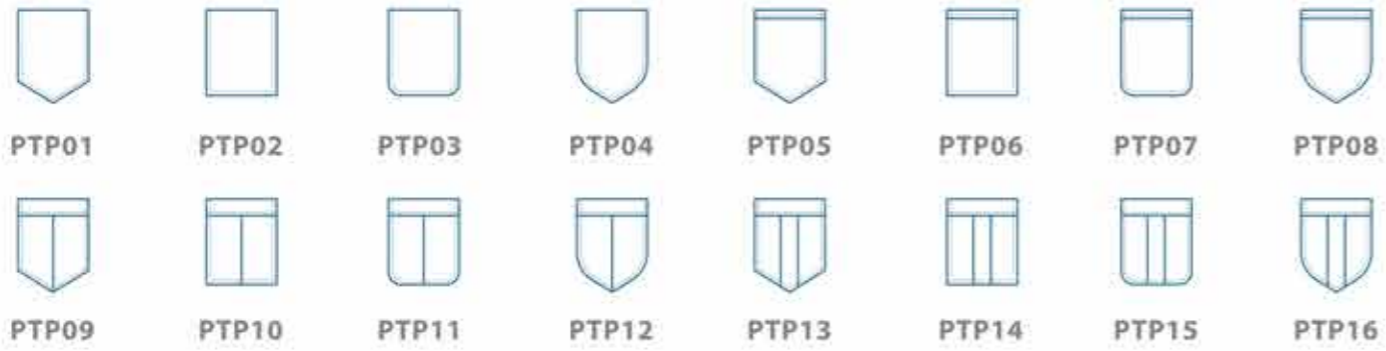

STYLES: JACKETS



STYLES: JACKETS (BACK)



STYLES: COLLAR



STYLES: SLEEVES

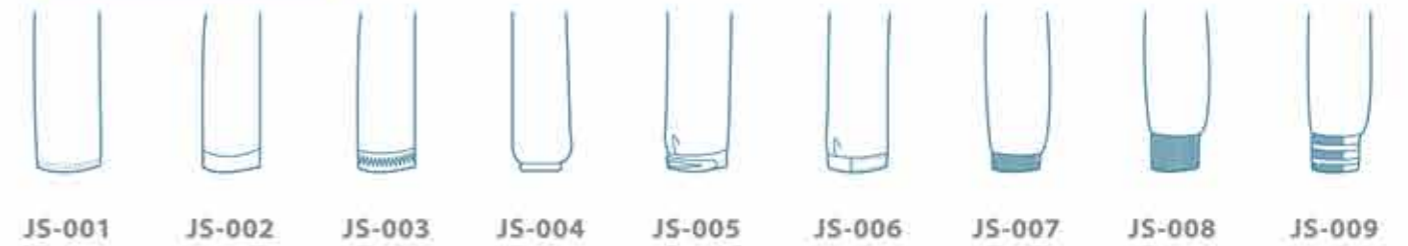

STYLES: POCKETS



STYLES: BUTTONS

** FOR POLO / SHIRT ONLY **



STYLES: ZIPPER HEAD

